

Station #2a

The Creek

2 Boxes of Targets
2 Report Pair (4)
Promatic then Manual

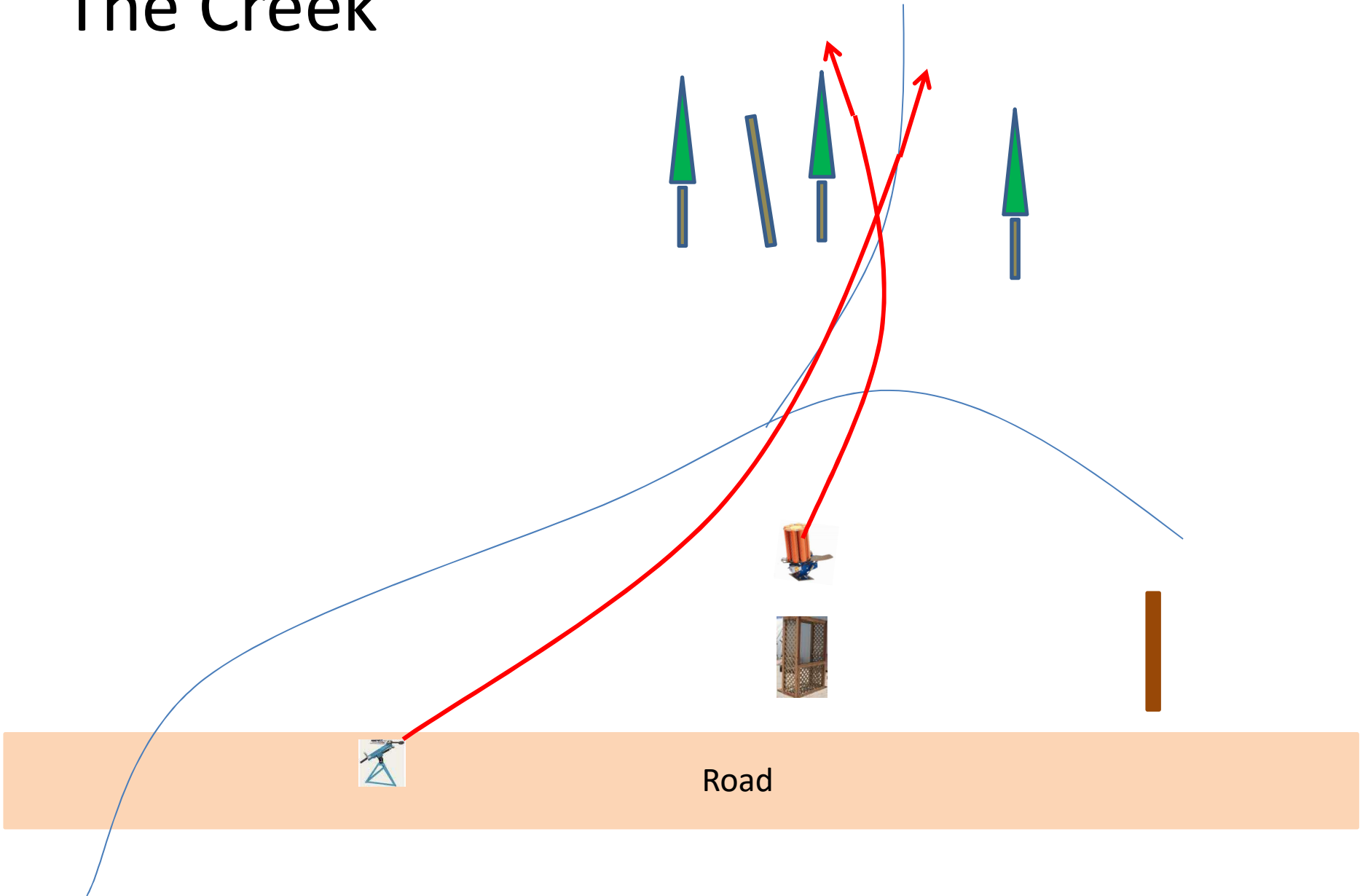

Station #3

The Bridge

3 Boxes of Targets
3 Report Pair (6)
Promatic then Manual

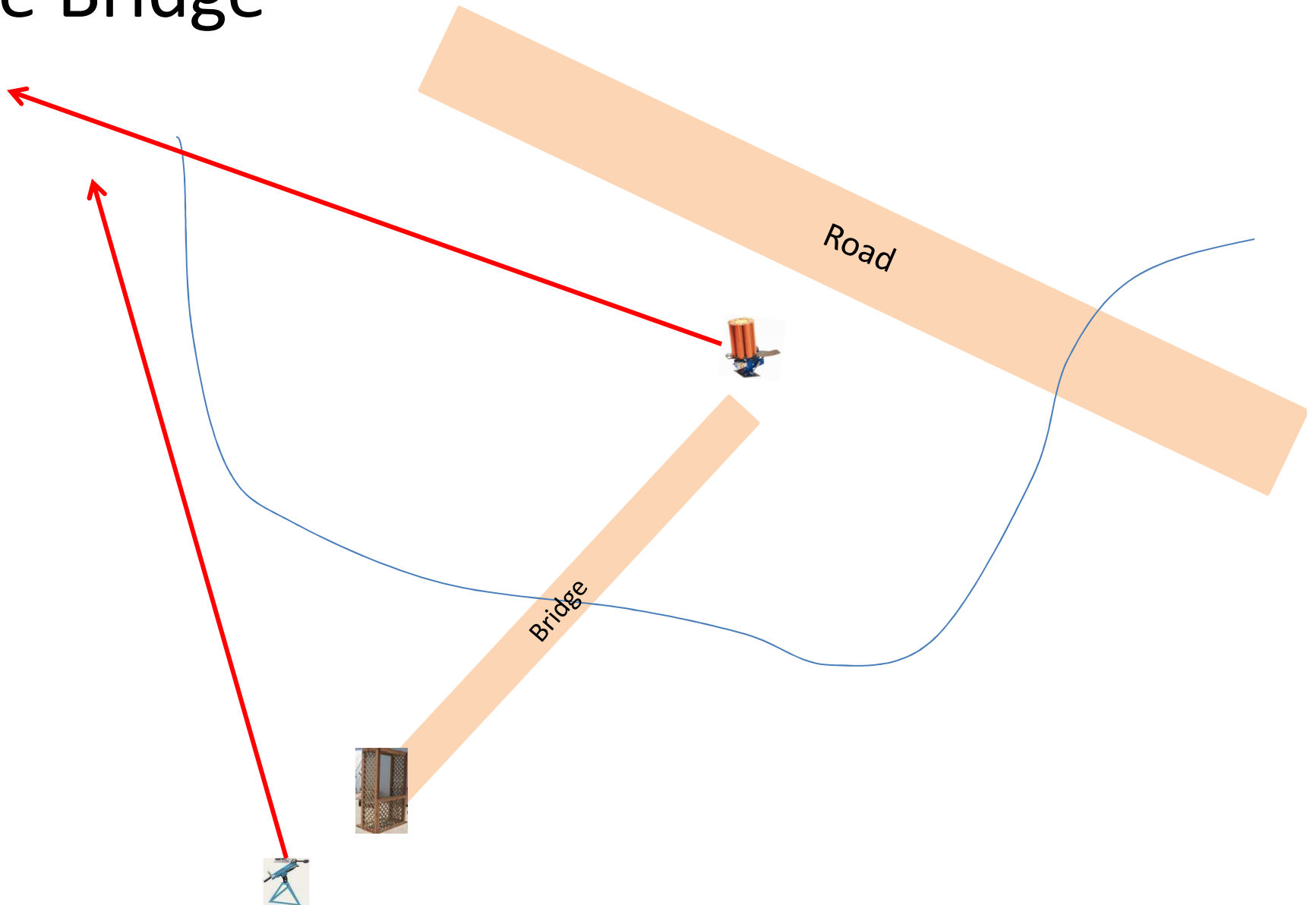

Station #14

Overhead

2 Boxes of Targets
2 Report Pair (4)
Promatic then Manual

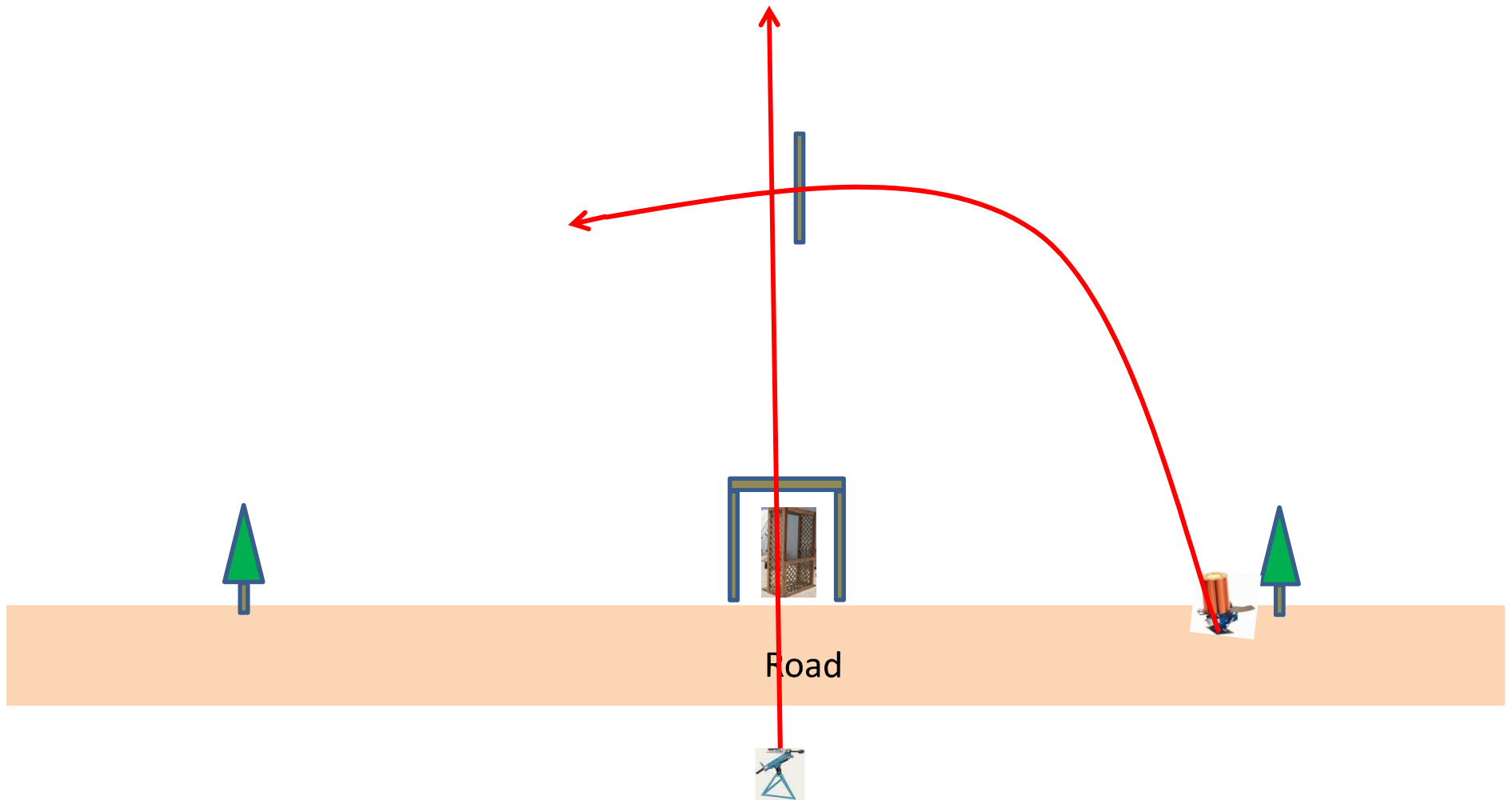

Station #13

Beer Can C

2 Boxes of Targets
2 Report Pair (4)
Promatic then Manual

Automatic

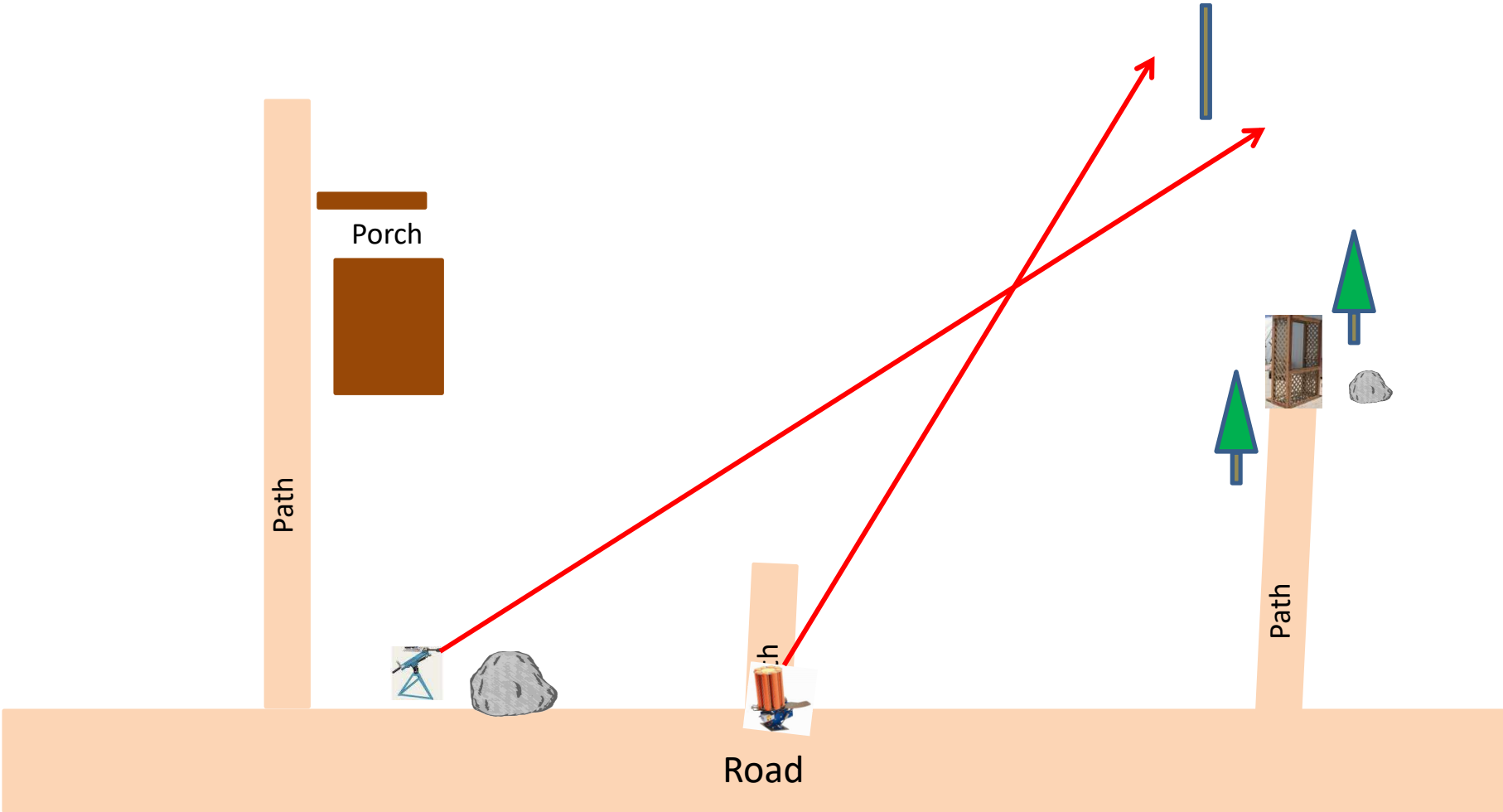

Station #12

Roadway West

2 Boxes of Targets
2 Report Pair (4)
Promatic then Manual

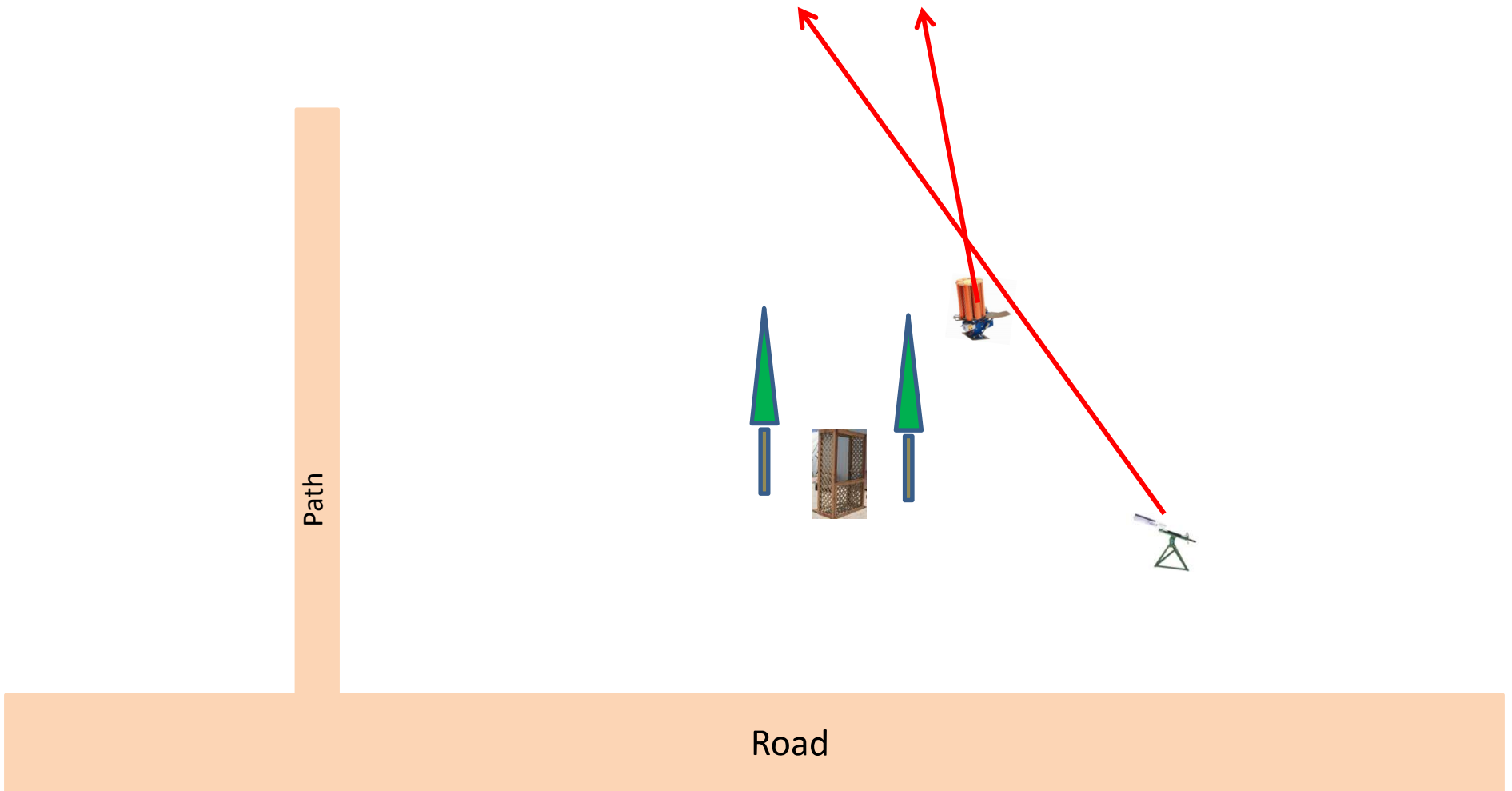

Station #4

Roadway East

Gun's and Roses

NOT USED

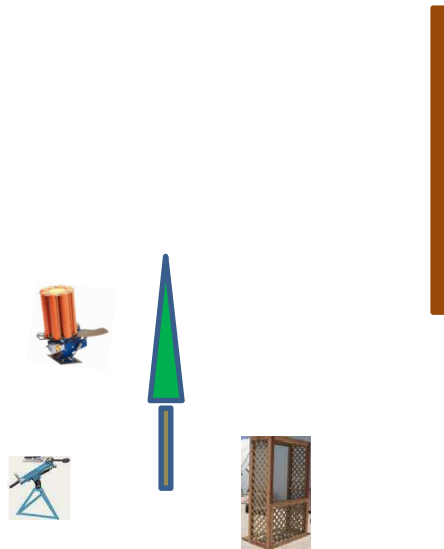

Road

Station #7

Old Rabbit

3 Boxes of Targets
3 Report Pair (6)
Promatic then Manual

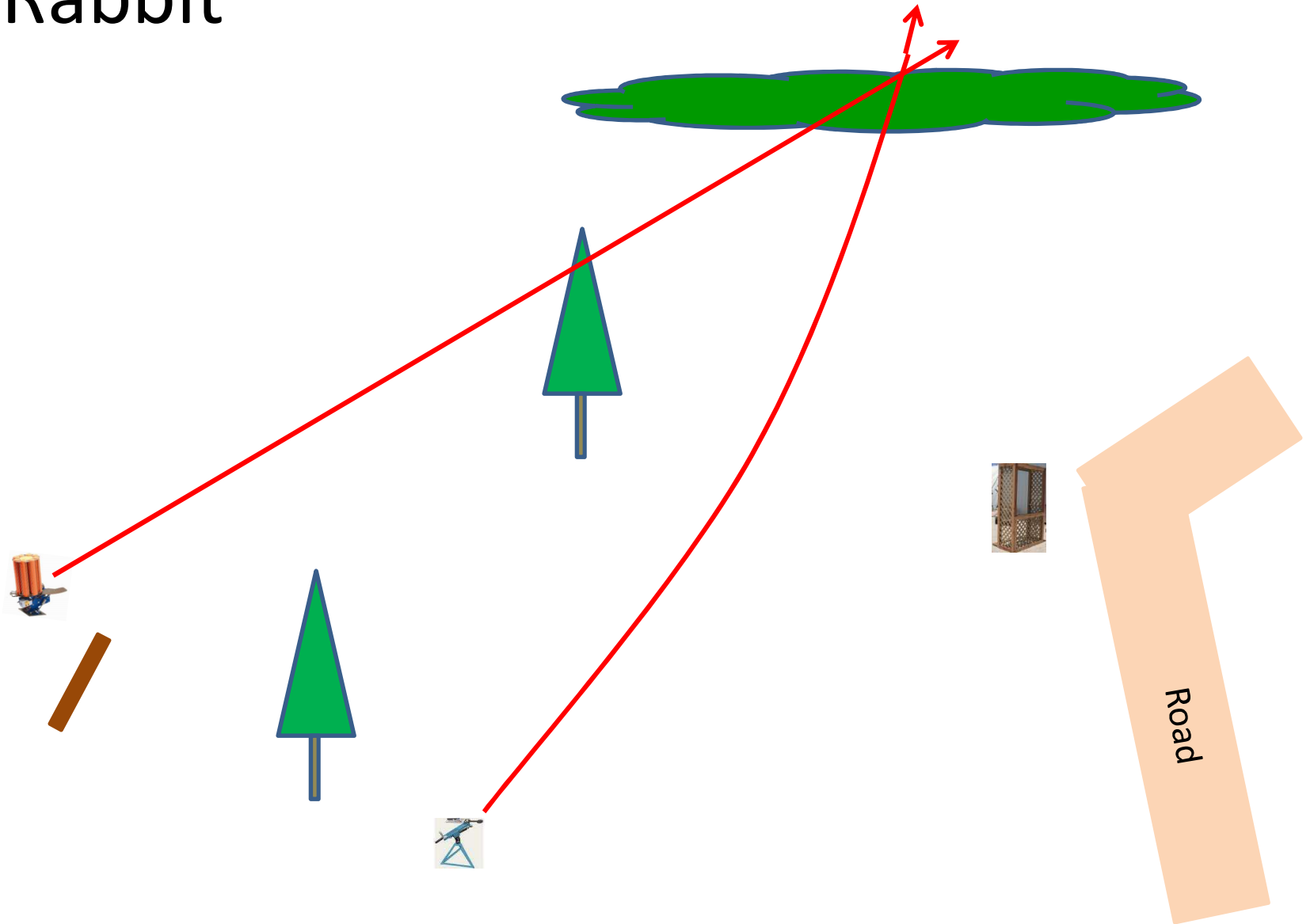

Station #8

The Teal

3 Boxes of Targets
3 Report Pair (6)
Promatic then Manual
****Find another Trap Instead of Teal****

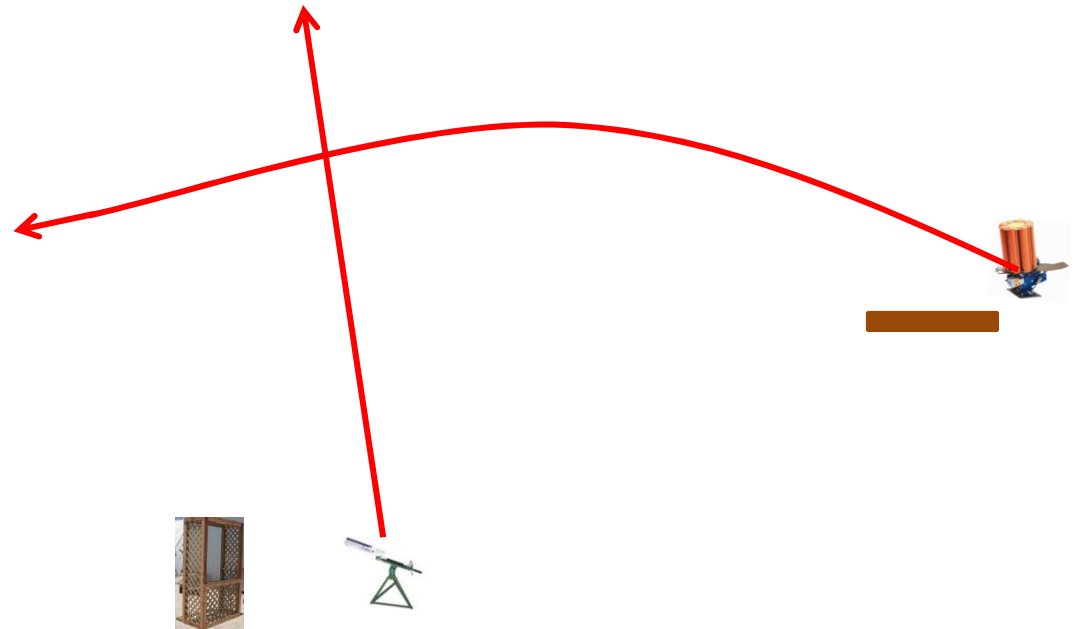

Road

Station #9

Far Roadway

2 Boxes of Targets (GREEN)
2 Report Pair (4)
Auto Rabbit then Manual

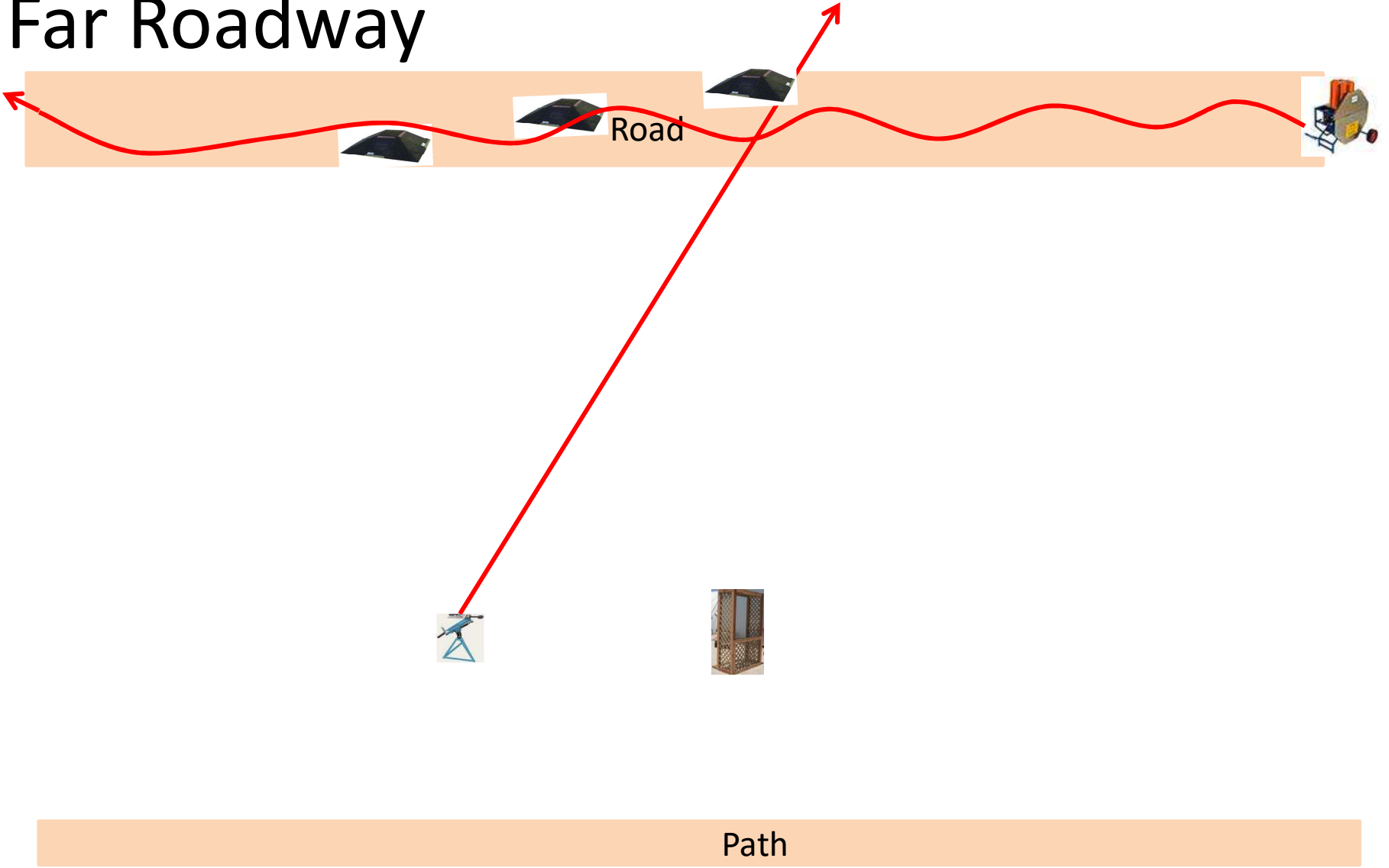

Station #10

The Bench

3 Boxes of Targets
3 Report Pair (6)
Chondel then Manual

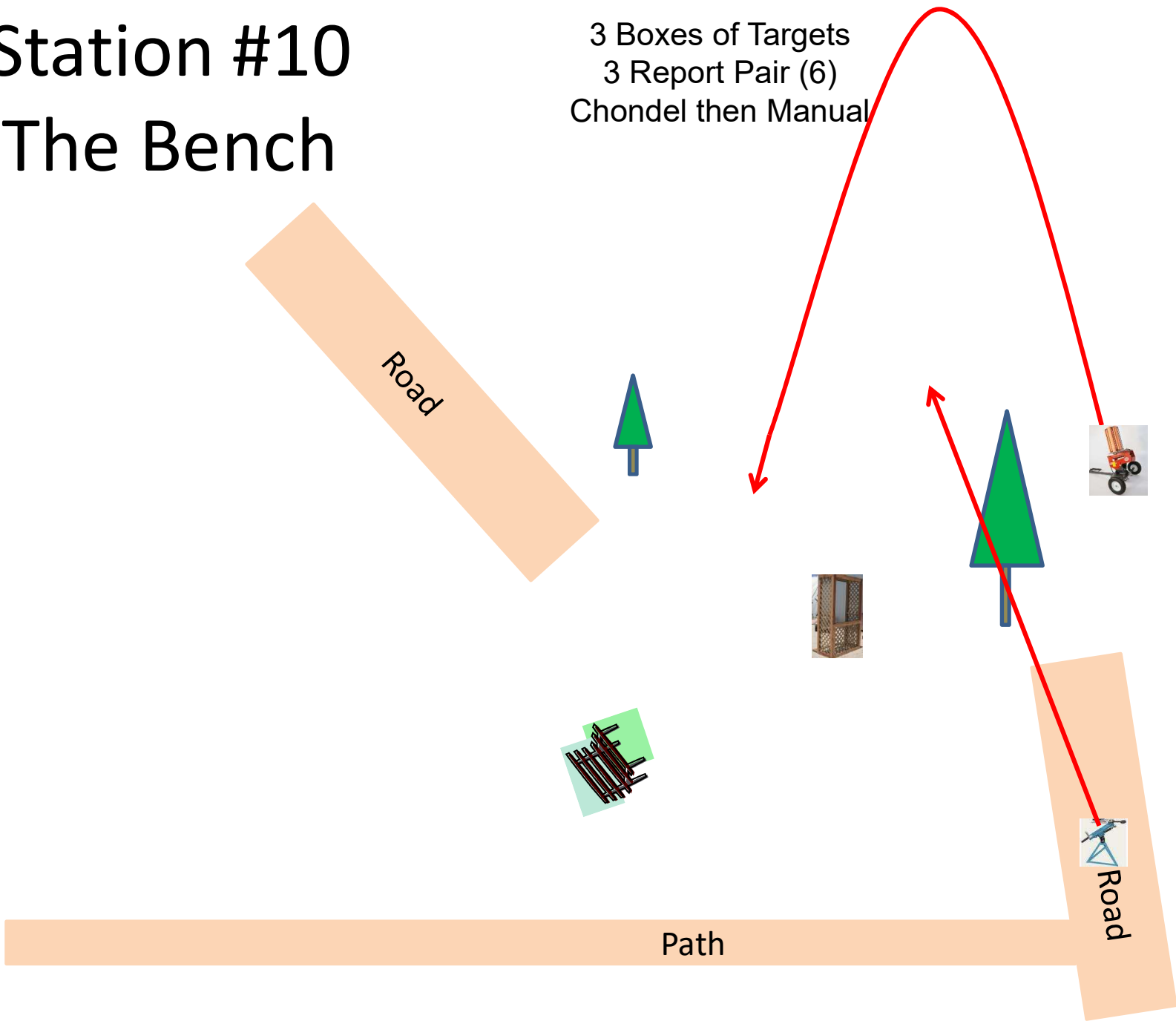

Station #11

The Zinger

3 Boxes of Targets
3 Report Pair (4)
Promatic then Manual

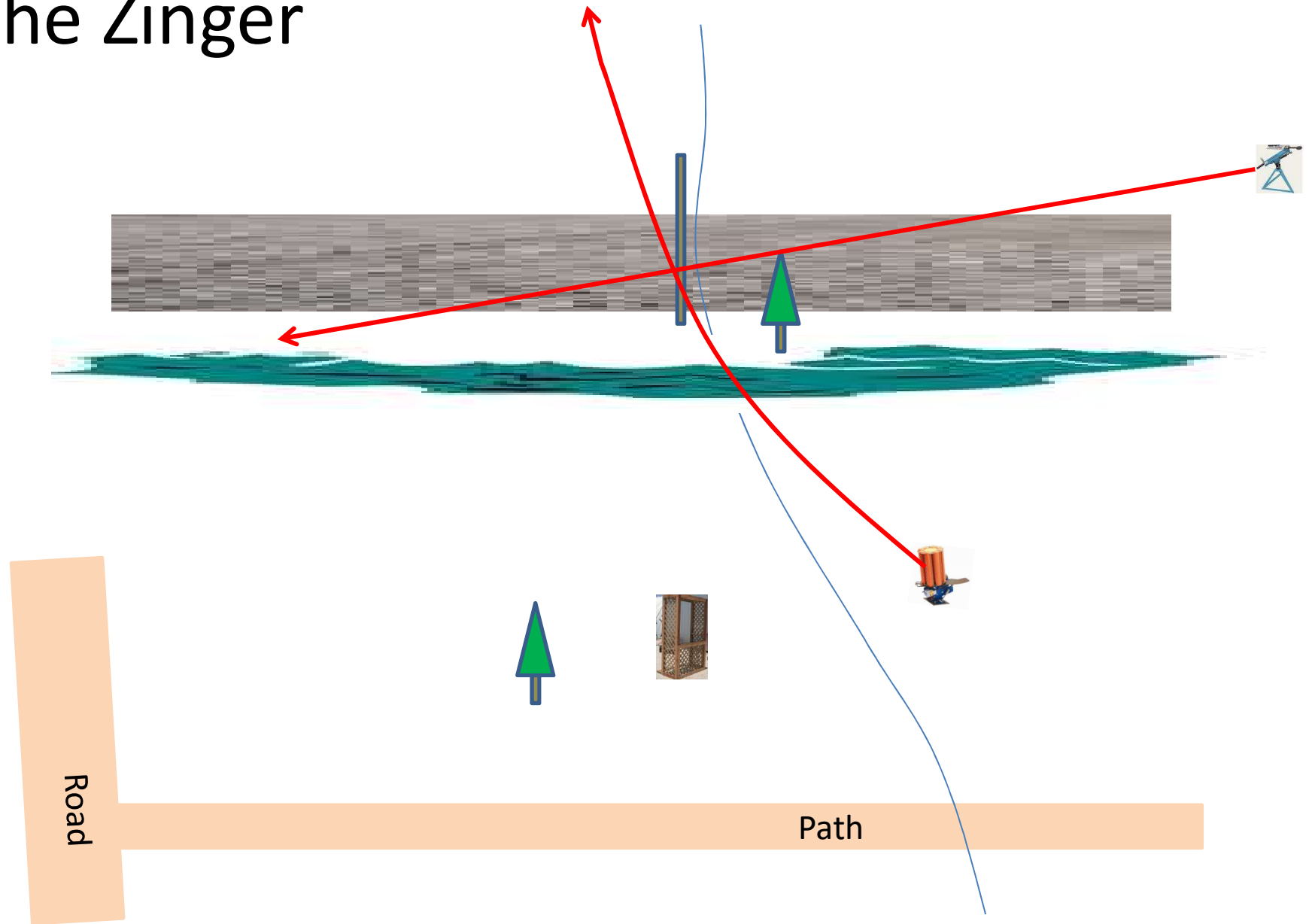

The Menu 07/01/2017

2b) The Creek B	- 2 Report Pair - Promatic then Manual	(4)
3) The Bridge	- 3 Report Pair - Promatic then Manual	(6)
13) Beer Can C	- 2 Report Pair - Promatic then Manual	(4)
4) Roadway West	- 2 Report Pair - Promatic then Manual	(4)
7) Old Rabbit	- 3 Report Pair - Promatic then Manual	(6)
8) The Teal	- 3 Report Pair - Promatic then Manual	(6)
9) Far Roadway	- 2 Report Pair - Auto Rabbit then Manual	(4)
10) The Bench	- 3 Report Pair - Chondel then Manual	(6)
11) Zinger	- 3 Report Pair - Promatic then Manual	(6)
12) Roadway East	- NOT USED	
14) Overhead	- 2 Report Pair - Promatic then Manual	(4)

		(50)